

# AIRES 35-V

posted 7-18-'03

- hence the images looked great at 800X640 !!  
This took me 1 1/2 hours to fix in 12-2016  
(double tabs - wrong indents)

This camera manual library is for reference  
and historical purposes, all rights reserved.

This page is copyright© by [mike@butkus.org](mailto:mike@butkus.org), M. Butkus, NJ.

This page may not be sold or distributed without  
the expressed permission of the producer  
I have no connection with any camera company

On-line camera manual library

[Back to main camera manual page](#)

**If you find this manual useful,  
how about a donation of \$3 to:**

M. Butkus, 29 Lake Ave.,  
High Bridge, NJ 08829-1701  
and send your e-mail address  
so I can thank you.

Most other places would charge  
you \$7.50 for a electronic copy  
or \$18.00 for a hard to read Xerox copy.

This will help me to continue to host this site,  
buy new manuals, and pay their shipping costs.

**It'll make you feel better, won't it ?**

**If you use Pay Pal, use the link below.  
Use the above address for a check, M.O. or cash.**



<https://www.PayPal.me/butkus>

**Venmo @mike-butkus-camera Ph 2083**

www.butkus.us

---



## CONTENTS

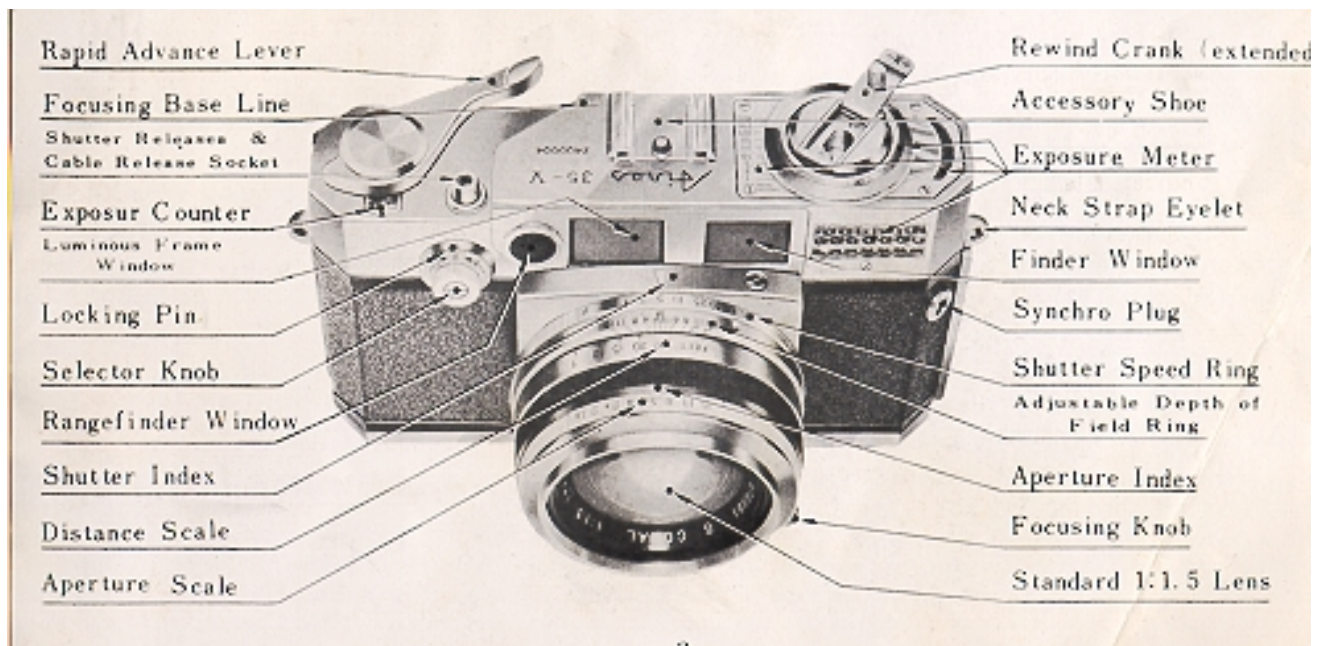

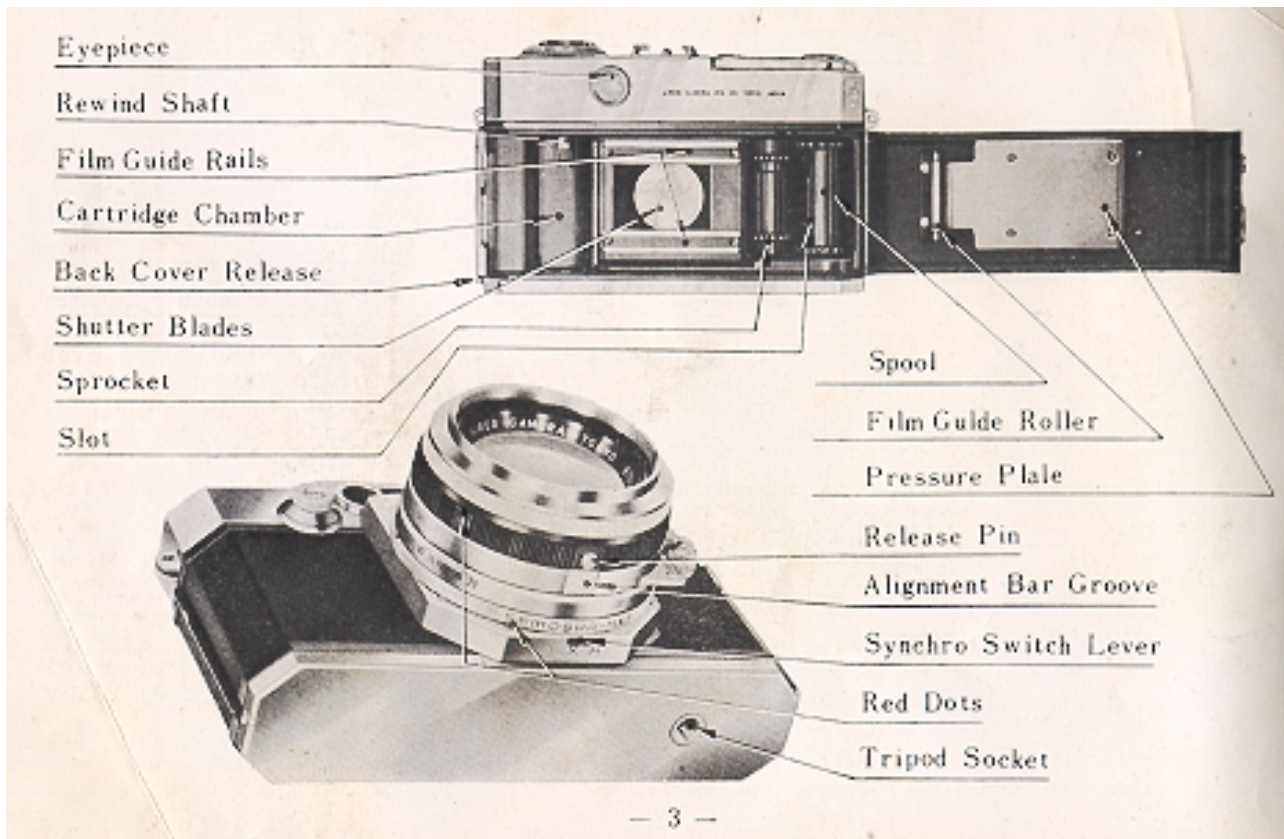

### **Introduction of Aires 35.V**

Combining precision, versatility, ease of operation, plus the outstanding features the consumer has come to expect from Aires, the New Aires is a compliment to the skill of the camera maker's art. A high precision, specially designed Seikosha MX shutter gives consistent exposures over the entire scale--action stopping 1/400 sec. to the slow full second for night scenes and available light photography--all of this and full synchronization for electronic and standard flash. The built in exposure meter provides accurate determining of exposure in all situations--daylight, indoors or in dim light with the amplifier cell. Rapid advance lever and rewind crank provides fast shooting plus speedy reloading. Smooth jar-free shutter release allows hand-held exposures at slower speeds. Quiet shutter for distraction free shooting in the studio or when working with models. Dependable, accurate, coupled rangefinder view Finder for all three lenses with provision for parallax correction in close-up photos. Handy drop-out film loading chamber. Engraved depth of field scale for all lenses. Double exposure prevention is automatic but may be made by turning the advance and rewind selector knob to "D". Amplifier cell's electrical connection is built into the accessory shoe. Automatic back cover lock. All of these features plus many others make the Aires 35-V the most outstanding camera to come from Japan in recent years.

### **Interchangeable Lens System**

The outstanding feature of the new Aires 35-V is its completely integrated interchangeable lens system. The integrated concept was achieved by specifically designing a behind-the-lens-shutter and body to match the outstanding advances of our optical specialists. Three completely new lenses, wide-angle, standard and telephoto incorporating the latest technical advances of the Japanese optical industry, were designed specifically for the integrated interchangeable-lens-shutter camera utilizing the basic Aires camera design as a starting point. With the completion of these new lenses the new camera was designed to match, feature to feature, the best in existing Aires cameras and those outstanding properties of the new lenses.

The camera possesses the ability to cope with almost any picture situation likely to be encountered by the user of a 35mm camera. Snapshots, action, sports, scenic, and many more come within the scope of the Aires 35-V.

Three completely new lenses, standard wide-angle and telephoto, were specially designed for the Aires 35-V. Particular attention was given to the integrated concept for matching three different focal lengths to a single bayonet focusing mount. Although new in design, none of the optical corrections essential to fine, precision 35mm photography were overlooked. Color corrections, longitudinal and lateral, have been carried out to a high degree. All lenses are hard coated to increase shadow detail and prevent flare. Mounted in precision-machined, matched bayonet mounts to assure permanent accuracy of focus, all have superb definition and resolving power.

Description of Parts (front, rear and bottom view) 2,3	Operating Instructions - - 14
Introduction of Aires 35-V 4	Loading 14
Interchangeable Lens System - 5	Determining Exposure with Aires Built-in Exposure Meter 16
Characteristics of the Aires Interchangeable Lenses 6	Focusing . - -17
Changing the Lens 8	Holding the camera when taking pictures 18
Removing the Lens 8	Framing 20
Setting the Adjustable Depth of Field Ring 9	Taking the picture 20
Replacing the Lens 10	Unloading the camera 20
Trimming Coupled Range Viewfinder 11	Miscellaneous Information -: 22
Rapid Winding of Film and Winding of Shutter 12	Self-timer and Cable Release Z
Flash Synchronization and Intentional Multiple Exposures 13	Depth of Field of the Lenses and their Utilization 22
Infrared Marking (The Red R) 14	Depth of Field Charts 24, 25, 26
	The care of your camera 27

# Characteristics of the Aires Interchangeable Lenses

## Standard lens - S Coral, f=4.5 F 1 :1.5, 7 elements 4 groups

This lens combines high speed and resolving power to cover a wide range of everyday photography. It is extremely useful in available light photography or for sports where high shutter speeds require a large diaphragm opening. Its superb definition makes it an excellent lens for general photography. Other data on the lens are as follows:

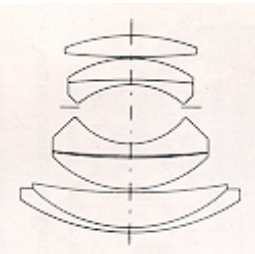
	<p>Sharp Image Field: 50degree 30 sec.            Perpendicular Angle of View :29"            Horizontal Angle of View: 43°            Diaphragm Openings: 1.5, 2, 2.8, 4, 5.6, 8, 11, 16            Lens Mount: Exclusive Bayonet Mount            Lens Front Attachment Size: Filter screw 49mm P=0.75            Outside dimension 51mm            Weight: approximately 51 ozs.</p>
---	---

**Telephoto Lens Tele Coral, f=10cm. F 1: 3.5, 5 elements 3 groups** High speed, long focal length combined with high resolving power anti definition plus superb color correction make this lens ideal for distant subjects and formal or informal portraiture. Image size is about twice that of standard lens. Focusing range is 7 feet to infinity. Other data on the lens are as follows:

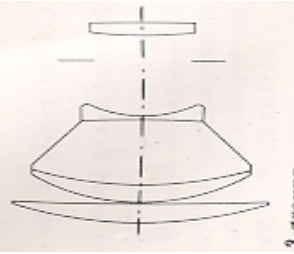
	<p>Sharp Image Field: 24° Perpendicular            Angle of View: 13°30' Horizontal Angle of View: 20 degrees            Diaphragm Opening: 3.5, 4, 5.6, 8, 11, 16, 22            Lens Mount: Exclusive Bayonet Mount            Lens Front Attachment Size : Filter screw : 62mm P=0.75            Outside dimension: 65mm            Weight: approx. 13 ozs.</p>
---	--

## Wide-Angle Lens--W Coral, f=3.5cm. F 1:3.2, 4 elements 3 groups

Medium wide-angle for close quarters work and where a large portion of the subject is desired in the picture. Color corrections, definition, resolving power are comparable to the other matched integrated lenses for the Aires 35-V. Short focal length of W Coral lens provides extended depth of field potentials. Focusing range is 2-2/3 feet to infinity. Also useful for dim-light photography. Bayonet mount couples to rangefinder. Other data on the lens are as follows:

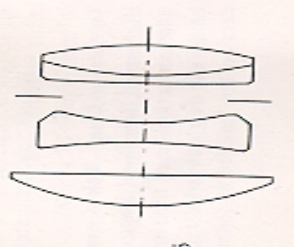
	<p>Sharp Image Field 63 degrees            Perpendicular Angle of View 37°30' Horizontal Angle of View 54            Diaphragm Openings 3.2, 4, 5.6, 8, 11, 16, 22            Lens Mount: Exclusive Bayonet Mount            Lens Front Attachment Size: Filter screw 49mm E2=0.75 Outside dimension: 51mm            Weight: approximately 51 ozs.</p>
---	---



## Changing the Lens

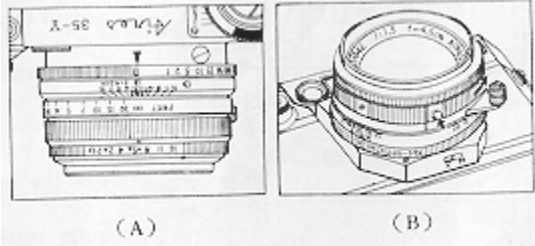

The Aires 35-V camera has an exclusive bayonet mount on the front which permits the removal and replacement of the interchangeable lens with speed and ease. When changing the lens, do so carefully. Especially, in replacing, be sure it is securely fitted to the lens mount. Care should be taken that the rear element of the lens will not be scratched when changing lens.

## Removing the Lens

Set the distance scale to infinity (A), by turning the focusing knob. Push the pin at the bottom of the lens barrel and simultaneously turn the knurled black ring counter clockwise until it stops (B). Now pull lens away from camera body.

## Setting the Adjustable Depth of Field Ring

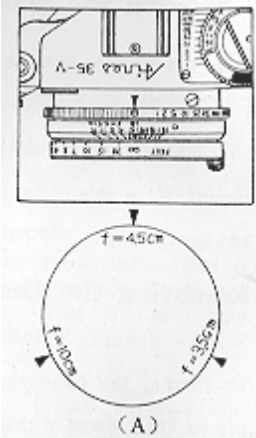

*Don't turn the Depth of Field ring unless the lens is removed.*  
For the three different lenses (Standard, Telephoto and Wide-Angle) there are three different Depth of Field markings engraved on the Depth of Field Ring as in the illustration on the right (A).

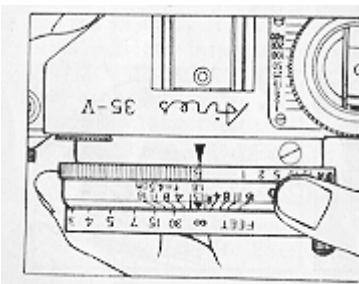

Press the small pin on the left side of the Standard lens Depth of Field Ring engraving and simultaneously turn ring either way so that the focal length (4.5cm, 10cm. or 3.5cm.) of the lens you are going to use is set at the red triangular mark on the shutter cover (B).

## Replacing the Lens

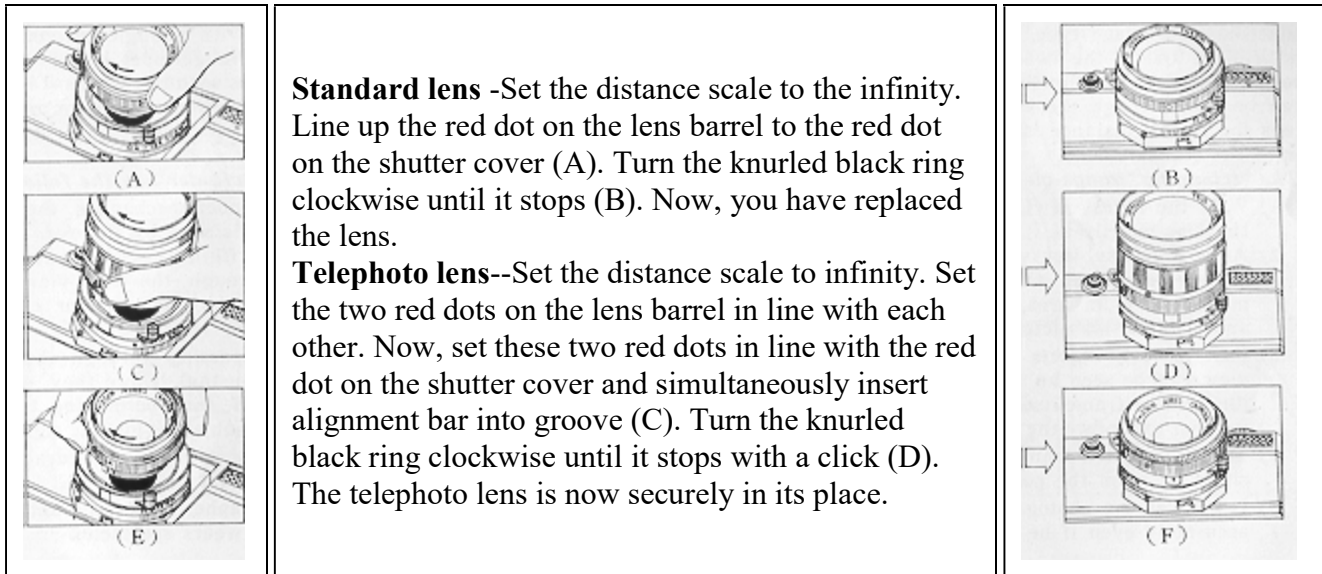

**Wide-Angle lens**--Set the distance scale to infinity. Set the two green dots on the lens barrel in line with each other: Now, set the red dot on the lens barrel to the red dot on the shutter cover and simultaneously insert alignment bar into groove (E). Turn the lens barrel clockwise until it stops with a click (F). The wide-angle lens is now securely in its place.

### "Trimming" Coupled Range-viewfinder

The Aires 35-V is equipped with a "trimming" coupled range-viewfinder mechanism of the super-imposed image type, with a single eyepiece. As the illuminated frame of the viewfinder is brilliant and as the two rangefinder images are very clear, it is easy to coincide them and to focus as close as 32 inches with the standard lens. The illustration shows the wide field that can be seen through the viewfinder eyepiece and the illuminated frames. With the telephoto lens the closest distance is 7 feet with the wide--angle lens the focus range is the same as with the standard lens.

*The "trimming" range-viewfinder has the following 5 advantages:*

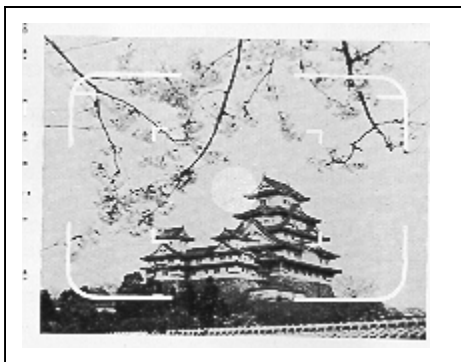

- 1.) With the Aires viewfinder mechanism, the subject shown in the frame is recorded by the lens exactly as it is seen by the eye.
- 2.) As only the subject within the illuminated frame is recorded by the lens and .... as the actual view seen through the full viewfinder is much larger in area, the photographer can frame and compose his picture very easily.

3.) Fast moving objects passing through the field of view can be seen an instant before they enter the illuminated frame itself, thus permitting the photographer to capture the subject at just the right instant.

4.) The illuminated frame will allow accurate composition in even the poorest light.

5.) It enables the photographer to see the entire image accurately even if he wears spectacles.

## Rapid Winding and Winding of Shutter

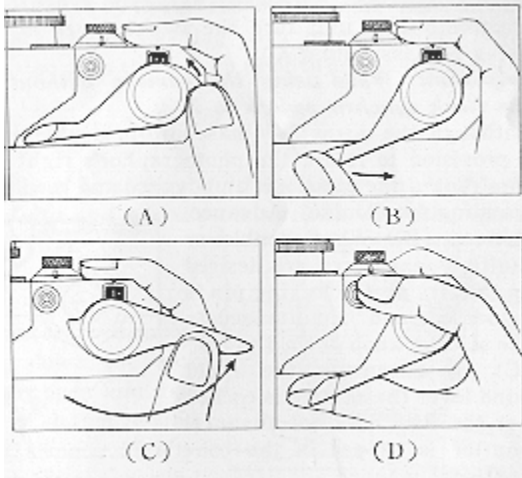

The Aires 35-V is so designed that both film advance and shutter winding can be performed at one and the same time, very rapidly, by means of the Rapid Advance Lever used as follows:

(1) Push the cove at the right corner of the lever with your index finger, and the lever comes into operating position (A).

2) Put your thumb alongside the Lever as in illustration (B) and turn it to the right until it stops (C).

3) Let your thumb slip off the Lever and it will return to position (D), ready for next picture.

The film has now been advanced one exposure and the shutter wound. Since the shutter cannot be released if you stop the Lever halfway, it is necessary that it should be turned until it goes no further. Double exposures are perfectly prevented. Since the Shutter Release is so conveniently located the index finger of your right hand fits over it naturally when you hold the camera. You can wind the film and release the shutter very rapidly, at the rate of 12 exposures per 10 seconds.

## Flash Synchronization and Intentional Multiple Exposures (A)

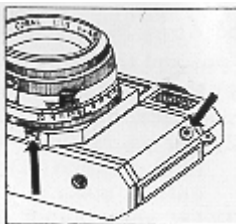

The Seikosha MX shutter has built-in synchronization for standard medium peak flash bulbs of the M class and electronic flash units having zero delay. Flash terminal is located on left front of the camera body and accepts European (RC) type synchro plugs. If you are using electronic flash unit turn the switch lever to X and to M if you are using M class bulb. (A)

**Important:** When using the camera without flash equipment set the flash synchro switch to X.

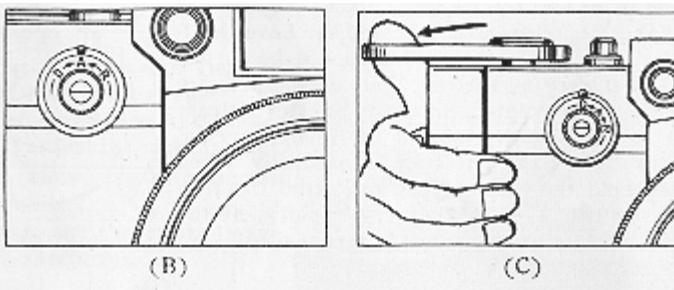

Although the Aires 35-V has built-in double exposure prevention device the designers added a provision to retain the photographer's right to take double exposures if he so desires. On the front of the camera is an advance and rewind selector knob with the markings of **D, A, R** standing for **Double, Advance, Rewind** (B). When double or multiple exposures are desired on one frame the locking pin is depressed and simultaneously the selector knob turned to " D " (C).



By advancing the rapid wind lever the shutter is wound but the film does not advance. Shutter is tripped in the conventional manner.

### Infrared Marking (The Red R)

Infrared film takes pictures by infrared waves invisible to human eyes. Focusing with this film is different from regular film and the lens must be focused slightly in front of the visible subject. A red mark is provided on the depth of field scale ring to compensate for this difference. Focus the camera in the regular way with the rangefinder and set the distance focused upon to this compensating mark before shooting with infrared film. When using the wide angle lens the depth of field is so deep there is no need to adjust the distance setting.

## OPERATING INSTRUCTIONS

*Please read the following instructions carefully at least once to familiarize yourself with the Aires features. Handle the camera carefully and operate the various operating parts at least once before loading your first roll of film.*

### Loading

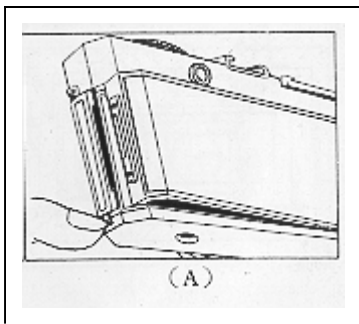

Place the camera face down on a table or other solid support and release the back cover lock by pulling down the lock release bar. The back cover will spring part-way open and may be opened fully by hand (A). Push upward on the slotted rewind shaft (B) (C) and insert a standard roll of 35mm cartridge film. Push the rewind shaft down until it engages the rewind slot in the cartridge spool (1).

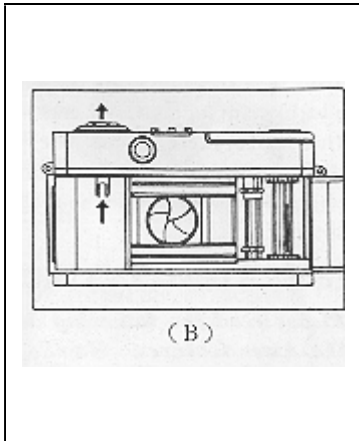

Bend the film tip about 1/8 inch from the end, and insert the film tongue in the slot of the take up spool making sure the film is securely fastened and that the sprocket gears fit the film perforations (E) Secure the film on the take-up spool by 1 1/2 turn of the take up spool and close back of the camera. Locking is automatic.

Now take up the slack by turning rewind lever clockwise until tension is felt. Advance the exposed portion of the film by winding the advance lever and tripping the shutter twice or until the counter registers 1. Your Aires is now loaded.

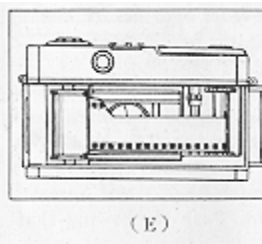
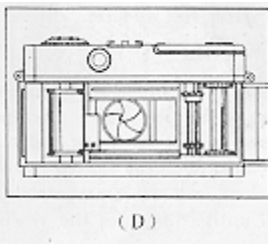
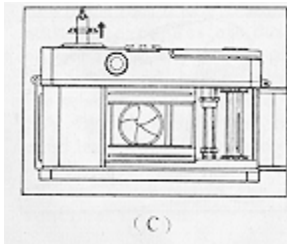

## Determining Expose with Aires Built-in Exposure Meter (A)

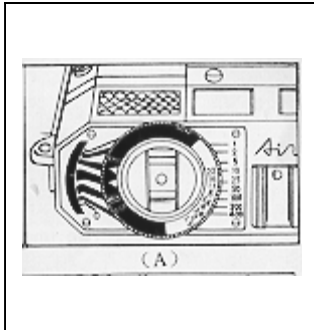

1. Set the ASA rating of the film loaded in the camera in the following manner: a. Determine the sensitivity of your film. (ASA number), b. Hold only the ASA and Aperture dial (knurled lower metal ring) with your left hand fingers and turn the small knob until the ASA number (in case ASA 100 film to 100) appears in the ASA window (B).

2. Point the photo-electric cell at the scene to be photographed. (In outdoor scenes point the cell slightly downward to minimize skylight reading.)

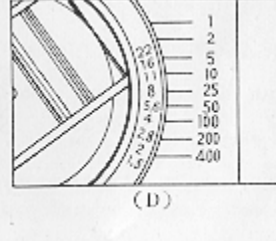
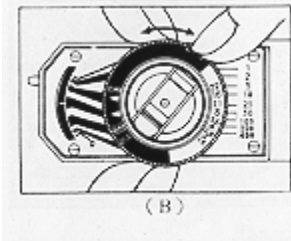

3. Set the Standard pointer ▲ on the ASA & Aperture Dial to this reading (C) and read the correct exposure from any of the combinations indicated on right of the exposure dial (D). Set the desired combinations to the shutter speed and aperture dials on the shutter and lens mount. Now, you are ready to focus the .. camera.

## Focusing



Look through the Aires "trimming" range-viewfinder. You will see two bright illuminated frames with a large bright dot of light in the center.

Inside the bright dot two images will be seen of the subject as can be seen from an example in the left top picture. By turning the focusing knob these two images can be made to merge as illustrated in the left bottom picture. At this point the object is in sharp focus.

The procedure is the same with the Standard and Wide-Angle lens but as mentioned on page 18 focusing is easier by turning the lens barrel when using the Telephoto lens.

# Holding the Camera When Taking Picture

## (A) Ordinary Horizontal Position



Hold the camera in both hands using the right index finger to operate the shutter release and left index or middle finger to adjust focusing. When using telephoto lens it is advisable to turn the lens barrel instead of focusing knob. To look through the viewfinder either the left or the right eye will do. Use whichever is convenient to you. Stabilize the camera by holding it so that the left hand thumb is pressed against your cheek.



## (B) Vertical Position

There are two ways to hold the camera for shooting vertical pictures. One is with shutter release above your eyes, (that is with your right hand above the camera).

The other is with the shutter release below eyelevel.

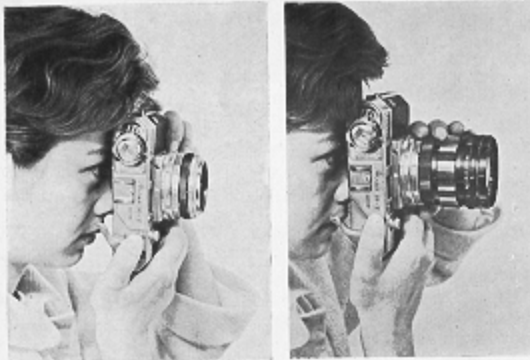

When the camera is held in the former way, the shutter release can be pressed with your right index or middle finger and film winding done without moving the camera from its shooting position. However, since the camera is held high, it is somewhat unstable especially for slow exposures. If the camera is held in the latter manner, the shutter release is pressed with your thumb.

When winding the film, your thumb is also used and has to be moved away from shutter release each time you wind the film. This position, however, is the more stable. Both ways have merits and there are pros and cons on them even among professionals. You must choose for yourself which suits you better. It is also up to you to decide which eye you can use more conveniently.

## Framing

With the Standard lens the outer bright illuminated frame is used to compose the picture.

For subjects between 3' ft. to 2 2/8 ft. use the parallel parallax correction marks as a substitute for top of the frame (standard lens). The center frame marks are for use with the Aires Tele Coral lens and the entire viewfinder is used with the 35mm Wide-angle, W Coral lens. With telephoto and wide angle lenses parallax may be compensated by a proportionate amount.

## Taking the Picture

With the subject in sharp focus and properly framed you are ready to take the picture. Press, gently, the shutter release on the top right of the camera, something like the trigger of a rifle. Press downward slowly until about half way and then at the precise moment of best expression or of peak action press all the way. A quiet click will be heard and you'll know the film has been exposed. Do not advance the rapid advance lever immediately unless you want to take another picture in the next few moments. By not winding the film immediately you preserve the life of the shutter mechanism.

## Unloading the Camera

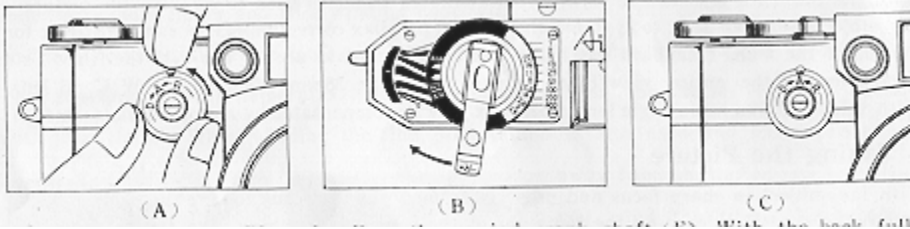
 <p>(A) (B) (C)</p>	<p>As each picture is taken it is recorded in the film exposure counter window. When the counter reaches 20 or 36, depending upon the length of roll, set the selector knob to "R" by depressing the locking pin and turning knob (A). Fold out the rapid rewind crank (B).</p>
---	---

3. Set the Standard pointer ▲ on the ASA & Aperture Dial to this reading (C) and read the correct exposure from any of the combinations indicated on right of the exposure dial (D). Set the desired combinations to the shutter speed and aperture dials on the shutter and lens mount. Now, you are ready to focus the .. camera.

## Focusing

	<p>Look through the Aires "trimming" range-viewfinder. You will see two bright illuminated frames with a large bright dot of light in the center.</p> <p>Inside the bright dot two images will be seen of the subject as can be seen from an example in the left top picture. By turning the focusing knob these two images can be made to merge as illustrated in the left bottom picture. At this point the object is in sharp focus.</p> <p>The procedure is the same with the Standard and Wide-Angle lens but as mentioned on page 18 focusing is easier by turning the lens barrel when using the Telephoto lens.</p>
---	---

# Holding the Camera When Taking Picture

## (A) Ordinary Horizontal Position



Hold the camera in both hands using the right index finger to operate the shutter release and left index or middle finger to adjust focusing. When using telephoto lens it is advisable to turn the lens barrel instead of focusing knob. To look through the viewfinder either the left or the right eye will do. Use whichever is convenient to you. Stabilize the camera by holding it so that the left hand thumb is pressed against your cheek.



## (B) Vertical Position

There are two ways to hold the camera for shooting vertical pictures. One is with shutter release above your eyes, (that is with your right hand above the camera).

The other is with the shutter release below eyelevel.

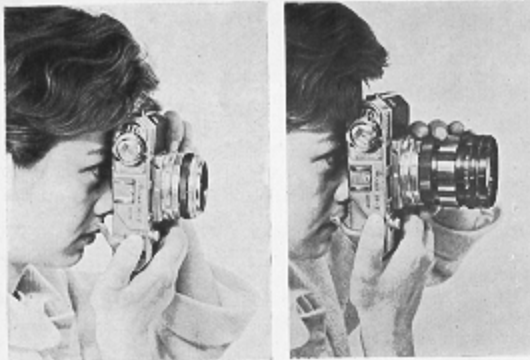

When the camera is held in the former way, the shutter release can be pressed with your right index or middle finger and film winding done without moving the camera from its shooting position. However, since the camera is held high, it is somewhat unstable especially for slow exposures. If the camera is held in the latter manner, the shutter release is pressed with your thumb.

When winding the film, your thumb is also used and has to be moved away from shutter release each time you wind the film. This position, however, is the more stable. Both ways have merits and there are pros and cons on them even among professionals. You must choose for yourself which suits you better. It is also up to you to decide which eye you can use more conveniently.

## Framing

With the Standard lens the outer bright illuminated frame is used to compose the picture.

For subjects between 3' ft. to 2 2/8 ft. use the parallel parallax correction marks as a substitute for top of the frame (standard lens). The center frame marks are for use with the Aires Tele Coral lens and the entire viewfinder is used with the 35mm Wide-angle, W Coral lens. With telephoto and wide angle lenses parallax may be compensated by a proportionate amount.

## Taking the Picture

With the subject in sharp focus and properly framed you are ready to take the picture. Press, gently, the shutter release on the top right of the camera, something like the trigger of a rifle. Press downward slowly until about half way and then at the precise moment of best expression or of peak action press all the way. A quiet click will be heard and you'll know the film has been exposed. Do not advance the rapid advance lever immediately unless you want to take another picture in the next few moments. By not winding the film immediately you preserve the life of the shutter mechanism.

## Unloading the Camera

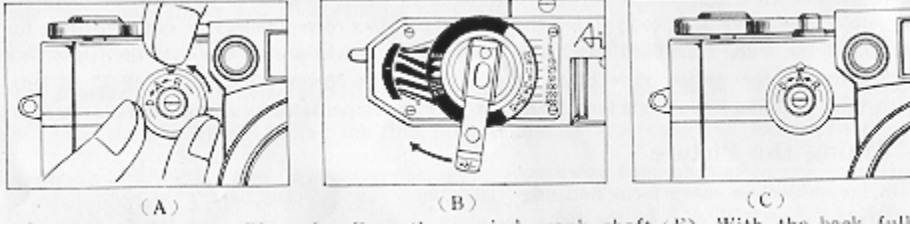
 <p>(A) Depressing the selector knob and turning it to 'R'. (B) Folding out the rapid rewind crank. (C) The camera with the back cover fully open.</p>	<p>As each picture is taken it is recorded in the film exposure counter window. When the counter reaches 20 or 36, depending upon the length of roll, set the selector knob to "R" by depressing the locking pin and turning knob (A). Fold out the rapid rewind crank (B).</p>
--	---

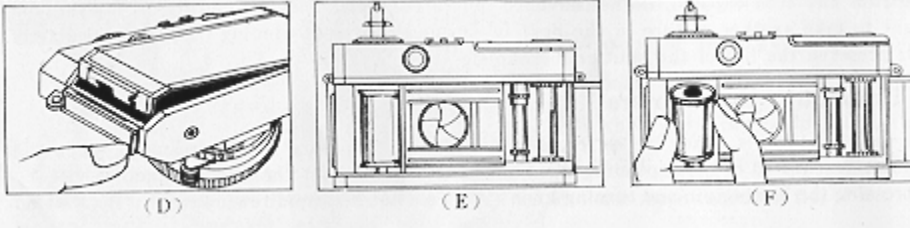
 <p>(D) Unlocking the back cover. (E) Pulling up the rewind crank shaft. (F) Returning the knob to 'A'.</p>	<p>Rewind the film into the film cartridge by turning the crank clockwise (in direction of the arrow) no felt on the crank. The film is now fully rewound. Return knob to "A" (C).</p>
--	--

Unlock the back cover (D). and pull up the rewind crank shaft (E). With the back fully open and the rewind crank and shaft in the "up" position the camera is turned over and the film will drop out of its own accord ,or it may it taken out as shown in (F).

## MISCELLANEOUS INFORMATION

### Self-timer and Cable Release

If the shutter speed is slower than 1/25 sec. use of cable release is advisable. The cable release or the self-timer should be screwed into the cable release socket on the shutter release before the shutter is wound. If they are screwed in after the shutter has been wound you might accidentally trip the shutter.

### Depth of Field of Photographic Lenses and their Utilization

Photographic lenses have a tendency to be in focus in front of and behind the subject focused on. For instance, if you focus on a person 10 feet away a clog closer than 10 feet and flowers further than 10 feet may also be in acceptable sharp focus. The range from the front limit to the rear limit in acceptable sharp focus is called the Depth of Field of a lens.



This range is shallow in the foreground and deep in the background and the limits varies with different lenses and also with the different apertures and distances as you can see from the Depth of Field Chart found elsewhere in this booklet.

In actual work the control of the Depth of Field serves as a tool to achieve desired effects and is utilized in the following two ways.

1. To get a sharp image of subjects located at different distances from the camera. Using a Depth of Field Chart Will enable you to control what will or what will not be sharp in your picture.
2. To limit sharpness, to concentrate attention on a certain part of the picture by having it sharp, making everything else blurred. Practice will teach you how to use and control this feature of the lens' depth of field.